

Medication Guide

Foradil® [FOR-a-dil] Aerolizer®

(formoterol fumarate inhalation powder)

Important: Do not swallow FORADIL capsules. FORADIL capsules are used only with the Aerolizer inhaler that comes with FORADIL AEROLIZER. Never place a capsule in the mouthpiece of the AEROLIZER Inhaler.

Read the Medication Guide that comes with FORADIL AEROLIZER before you start using it and each time you get a refill. There may be new information. This Medication Guide does not take the place of talking to your health care provider about your medical condition or treatment.

What is the most important information I should know about FORADIL AEROLIZER?

FORADIL AEROLIZER can cause serious side effects, including:

1. People with asthma who take long-acting beta₂-adrenergic agonist (LABA) medicines, such as formoterol fumarate inhalation powder (FORADIL AEROLIZER), have an increased risk of death from asthma problems.

- Call your healthcare provider if breathing problems worsen over time while using FORADIL AEROLIZER. You may need a different treatment.
- Get emergency medical care if:
 - breathing problems worsen quickly, and
 - you use your rescue inhaler medicine, but it does not relieve your breathing problems.

2. Do not use FORADIL AEROLIZER as your only asthma medicine. FORADIL AEROLIZER must only be used with a long-term asthma control medicine, such as an inhaled corticosteroid.

3. When your asthma is well controlled, your healthcare provider may tell you to stop taking FORADIL AEROLIZER. Your healthcare provider will decide if you can stop FORADIL AEROLIZER without loss of asthma control. You will continue taking your long-term asthma control medicine, such as an inhaled corticosteroid.

4. Children and adolescents who take LABA medicines may have an increased risk of being hospitalized for asthma problems.

What is FORADIL AEROLIZER?

FORADIL AEROLIZER is a long-acting beta₂-agonist (LABA). LABA medicines help the muscles around the airways in your lungs stay relaxed to prevent asthma symptoms, such as wheezing and shortness of breath. These symptoms can happen when the muscles around the airways tighten. This makes it hard to breathe. In severe cases, wheezing can stop your breathing and cause death if not treated right away.

FORADIL AEROLIZER is used for asthma, exercise-induced bronchospasm (EIB) and chronic obstructive pulmonary disease (COPD) as follows:

Asthma

FORADIL AEROLIZER is used with a long-term asthma control medicine, such as an inhaled corticosteroid, in adults and children ages 5 and older:

- to control symptoms of asthma, and
- to prevent symptoms such as wheezing

LABA medicines, such as FORADIL AEROLIZER, increase the risk of death from asthma problems. FORADIL AEROLIZER is not for adults and children with asthma who are well controlled with long-term asthma control medicine, such as low to medium dose of an inhaled corticosteroid medicine.

Exercise-Induced Bronchospasm (EIB)

FORADIL AEROLIZER is used to prevent wheezing caused by exercise in adults and children 5 years of age and older.

- If you have EIB only, your healthcare provider may prescribe only FORADIL AEROLIZER for your condition
- If you have EIB and asthma, your healthcare provider should also prescribe a long-term asthma control medicine, such as an inhaled corticosteroid.

Chronic Obstructive Pulmonary Disease (COPD)

FORADIL AEROLIZER is used long-term, 2 times each day (morning and evening), to control symptoms of COPD and prevent wheezing in adults with COPD.

Who should not use FORADIL AEROLIZER?

- Do not take FORADIL AEROLIZER to treat your asthma without a long-term asthma control medicine, such as an inhaled corticosteroid.
- If you are allergic to formoterol fumarate or any of the ingredients in FORADIL AEROLIZER. Ask your healthcare provider if you are not sure. See the end of this Medication Guide for a complete list of ingredients in FORADIL AEROLIZER.

What should I tell my healthcare provider before using FORADIL AEROLIZER?

Tell your healthcare provider about all of your health conditions, including if you:

- have heart problems
- have high blood pressure
- have seizures
- have thyroid problems
- have diabetes
- are pregnant or planning to become pregnant. It is not known if FORADIL AEROLIZER may harm your unborn baby.
- are breastfeeding. It is not known if FORADIL AEROLIZER passes into your milk and if it can harm your baby.
- are allergic to FORADIL AEROLIZER, any other medicines, or food products.

FORADIL AEROLIZER contains lactose (milk sugar) and a small amount of milk proteins. It is possible that allergic reactions may happen in patients who have a severe milk protein allergy.

Tell your healthcare provider about all the medicines you take including prescription and non-prescription medicines, vitamins, and herbal supplements. FORADIL AEROLIZER and certain other medicines may interact with each other. This may cause serious side effects.

Know the medicines you take. Keep a list and show it to your healthcare provider and pharmacist each time you get a new medicine.

How do I use FORADIL capsules with the Aerolizer inhaler?

See the step-by-step instructions for using FORADIL Capsules with the Aerolizer inhaler at the end of this Medication Guide. Do not use FORADIL unless your healthcare provider has taught you and you understand everything. Ask your healthcare provider or pharmacist if you have any questions.

- Children should use FORADIL AEROLIZER with an adult's help, as instructed by the child's healthcare provider.
- Use FORADIL AEROLIZER exactly as prescribed. **Do not use FORADIL AEROLIZER more often than prescribed.**
- For asthma and COPD, the usual dose is 1 FORADIL capsule inhaled through the AEROLIZER inhaler 2 times each day (morning and evening). The 2 doses should be about 12 hours apart.
- For preventing exercise-induced bronchospasm, the usual dose is 1 FORADIL capsule inhaled through the AEROLIZER inhaler at least 15 minutes before exercise, as needed. Do not use FORADIL AEROLIZER more often than every 12 hours. Do not use extra FORADIL AEROLIZER before exercise if you already use it 2 times each day.
- If you miss a dose of FORADIL AEROLIZER, just skip that dose. Take your next dose at your usual time. Never take 2 doses at one time.
- Do not use a spacer device with FORADIL AEROLIZER.

- Do not breathe into FORADIL AEROLIZER.
- While you are using FORADIL AEROLIZER 2 times each day, do not use other medicines that contain a long-acting beta₂-agonist (LABA) for any reason. Ask your healthcare provider or pharmacist for a list of these medicines.
- Do not stop using FORADIL AEROLIZER or any of your asthma medicines unless told to do so by your healthcare provider because your symptoms might get worse. Your healthcare provider will change your medicines as needed.
- FORADIL AEROLIZER does not relieve sudden symptoms. Always have a rescue inhaler medicine with you to treat sudden symptoms. If you do not have an inhaled, short-acting bronchodilator, contact your healthcare provider to have one prescribed for you.
- **Call your healthcare provider or get medical care right away if:**
 - your breathing problems worsen with FORADIL AEROLIZER
 - you need to use your rescue inhaler medicine more often than usual
 - your rescue inhaler medicine does not work as well for you at relieving symptoms
 - you need to use 4 or more inhalations of your rescue inhaler medicine for 2 or more days in a row
 - you use 1 whole canister of your rescue inhaler medicine in 8 weeks time
 - your peak flow meter results decrease. Your healthcare provider will tell you the numbers that are right for you.
 - you have asthma and your symptoms do not improve after using FORADIL AEROLIZER regularly for 1 week.

What are the possible side effects with FORADIL AEROLIZER?

FORADIL AEROLIZER may cause serious side effects, including:

- **See “What is the most important information I should know about FORADIL AEROLIZER?”**
- **Bronchospasm with wheezing or coughing and difficulty breathing**
- **Low blood potassium** (which may cause symptoms of muscle spasm, muscle weakness or abnormal heart rhythm)
- **Fast or irregular heart beat** (palpitations)
- **Serious allergic reactions including rash, hives, swelling of the face, mouth, and tongue, and breathing problems.** Call your healthcare provider or get emergency medical care if you get any symptoms of a serious allergic reaction.

Other possible side effects with FORADIL AEROLIZER include:

- chest pain

- increased blood pressure
- nervousness
- dry mouth
- muscle cramps
- nausea
- dizziness
- tiredness
- high blood sugar
- high blood acid
- trouble sleeping

Common side effects with FORADIL AEROLIZER include:

- headache
- tremor

Tell your healthcare provider about any side effect that bothers you or that does not go away.

These are not all the side effects with FORADIL AEROLIZER. Ask your healthcare provider or pharmacist for more information.

Call your doctor for medical advice about side effects. You may report side effects to FDA at 1-800-FDA-1088.

How do I store FORADIL AEROLIZER?

- Store FORADIL AEROLIZER at room temperature between 68°F and 77°F (20°C to 25°C). Protect FORADIL AEROLIZER from heat and moisture. Do not remove FORADIL capsules from their foil package until just before use.
- Always discard the old AEROLIZER inhaler by the "Use by" date and use the new one provided with each new prescription.
- Safely discard FORADIL capsules and the Aerolizer inhaler if no longer needed or is out-of-date.
- **Keep FORADIL AEROLIZER and all medicines out of the reach of children.**

General Information about FORADIL AEROLIZER

Medicines are sometimes prescribed for purposes other than those listed in a Medication Guide. Do not use FORADIL AEROLIZER for a condition for which it was not prescribed. Do not give FORADIL AEROLIZER to other people, even if they have the same condition. It may harm them.

This Medication Guide summarizes the most important information about FORADIL AEROLIZER. If you would like more information, talk with your healthcare provider. You can ask your healthcare provider or pharmacist for

information about FORADIL AEROLIZER that was written for healthcare professionals. If you have any questions about the use of FORADIL AEROLIZER, call (toll-free) 1-800-526-4099 or go to www.foradil.us.

What are the ingredients in FORADIL AEROLIZER?

Active ingredient: formoterol fumarate

Inactive ingredients: lactose (contains milk proteins), gelatin (capsule shell)

Instructions for Using FORADIL AEROLIZER

Do not swallow FORADIL capsules.

Follow the instructions below for using your FORADIL AEROLIZER. **You will breathe-in (inhale) the medicine in the FORADIL capsules from the FORADIL AEROLIZER.** If you have any questions, ask your healthcare provider or pharmacist.

FORADIL AEROLIZER

- **FORADIL AEROLIZER consists of FORADIL capsules and a AEROLIZER Inhaler.**
- **FORADIL capsules come on blister cards and are wrapped in foil pouches. Do not open a foil pouch until you are ready to use FORADIL AEROLIZER.**
- **Keep your FORADIL and AEROLIZER Inhaler dry. Handle with DRY hands.**



Aluminum pouch covering the foil blister cards

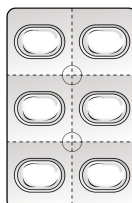

Foil blister card

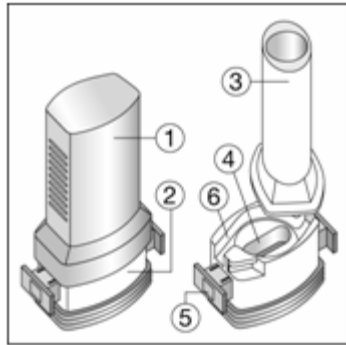

The Aerolizer consists of the following parts:

1. A cap to protect the mouthpiece of the base
2. A base that allows the proper release of medicine from the capsule. The base consists of:
 3. A mouth piece
 4. A capsule chamber
 5. A button with "winglets" (projecting side pieces) and pins on each side
 6. An air inlet channel.

With each new prescription of FORADIL AEROLIZER or refill, your pharmacist should have written the "Use by" date on the sticker on the outside of the FORADIL AEROLIZER box. Remove the "Use by" sticker on the box and place it on the AEROLIZER Inhaler cover that comes with FORADIL. If the sticker is blank, count 4 months from the date you got your FORADIL AEROLIZER from the pharmacy and write this date on the sticker. Also, check the expiration date stamped on the box. If this date is less than 4 months from your purchase date, write this date on the sticker.

Do not use FORADIL capsules with any other capsule inhaler, and do not use the AEROLIZER inhaler to take any other capsule medicine.

Taking a dose of FORADIL AEROLIZER requires the following steps:

1. Open the foil pouch containing a blister card of FORADIL capsules. Do not remove a FORADIL capsule until you are ready for a dose.
2. Pull off the AEROLIZER Inhaler cover. (Figure 1)

Figure 1

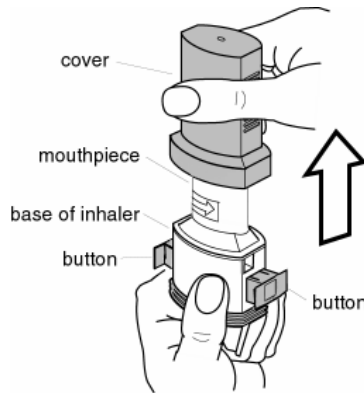

3. Hold the base of the AEROLIZER Inhaler firmly and twist the mouthpiece in the direction of the arrow to open. (Figure 2) Push the buttons in on each side to make sure that you can see 4 pins in the capsule well of the AEROLIZER Inhaler.

Figure 2



4. Separate one FORADIL capsule blister by tearing at the pre-cut lines. (Figure 3)

Figure 3

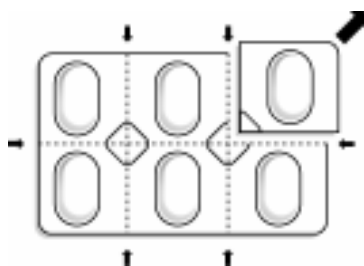

5. Peel the paper backing that covers one FORADIL capsule on the blister card. Push the FORADIL capsule through the foil. (Figure 4)

Figure 4

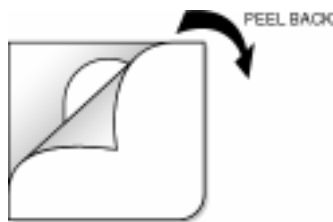

6. Place the FORADIL capsule in the capsule-chamber in the base of the AEROLIZER Inhaler. **Never place a capsule directly into the mouthpiece.** (Figure 5)

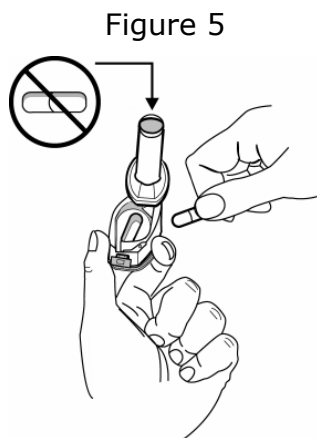

7. Twist the mouthpiece back to the closed position. (Figure 6)



8. Hold the mouthpiece of the AEROLIZER Inhaler upright and press both buttons at the same time. Only press the buttons **ONCE**. You should hear a click as the FORADIL capsule is being pierced. (Figure 7)

Figure 7

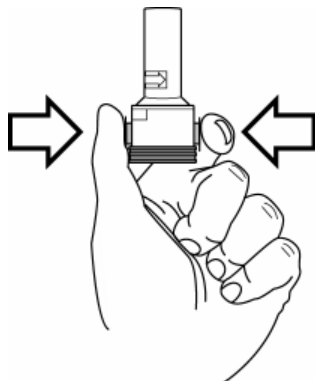

9. Release the buttons. If the buttons stay stuck, grasp the wings on the buttons and pull them out of the stuck position before the next step. Do not push the buttons a second time. This may cause the FORADIL capsule to break into small pieces. There is a screen built into the AEROLIZER Inhaler to hold these small pieces. It is possible that tiny pieces of a FORADIL capsule might reach your mouth or throat when you inhale the medicine. This will not harm you, but to avoid this, only pierce the capsule once. The FORADIL capsules are also less likely to break into small pieces if you store them the right way (See "How do I store FORADIL AEROLIZER?").

10. Breathe out (exhale) fully. **Do not exhale into the AEROLIZER mouthpiece.** (Figure 8)

Figure 8



11. Tilt your head back slightly. Keep the AEROLIZER Inhaler level, with the blue buttons to the left and right (**not up and down**). Place the mouthpiece in your mouth and close your lips around the mouthpiece. (Figures 9 and 10)



CORRECT

Figure 9

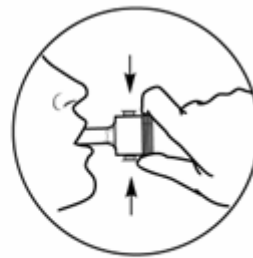

INCORRECT

Figure 10

12. Breathe in quickly and deeply (Figure 11). This will cause the FORADIL capsule to spin around in the chamber and deliver your dose of medicine. You should hear a whirring noise and experience a sweet taste in your mouth. If you do not hear the whirring noise, the capsule may be stuck. If this occurs, open the AEROLIZER Inhaler and loosen the capsule allowing it to spin freely. **Do not try to loosen the capsule by pressing the buttons again.** (You will have to repeat steps 10 to 12 again to get your dose.)

Figure 11



13. Remove the AEROLIZER Inhaler from your mouth. Continue to hold your breath as long as you can and then exhale.

14. Open the AEROLIZER Inhaler to see if any powder is still in the capsule. If any powder remains in the capsule repeat steps 10 to 13. Most people are able to empty the capsule in one or two inhalations.

15. After use, open the AEROLIZER Inhaler, remove and discard the empty capsule. Do not leave a used capsule in the chamber.

16. Close the mouthpiece and replace the cover.

Remember:

- Never breathe into the AEROLIZER Inhaler.

- Never take the AEROLIZER Inhaler apart.
- Never place a FORADIL capsule directly into the mouthpiece of the AEROLIZER Inhaler.
- Never leave a used FORADIL capsule in the AEROLIZER Inhaler chamber.
- Always use the AEROLIZER Inhaler in a level position.
- Never wash the AEROLIZER Inhaler. **Keep it dry.**
- Always keep the AEROLIZER Inhaler and FORADIL capsules in a dry place.
- Always use the new AEROLIZER Inhaler that comes with your refill.

Rx only



SCHERING CORPORATION

Manufactured by:

Novartis Pharma AG, Basle, Switzerland

for

Schering Corporation, Kenilworth, NJ 07033

FORADIL is a registered trademark of Astellas Pharma Inc.

AEROLIZER is a registered trademark of Novartis AG.

© 2010 Novartis Pharmaceuticals Corporation. All rights reserved.

May 2010

XXXXXXX

This Medication Guide has been approved by the U.S. Food and Drug Administration.